







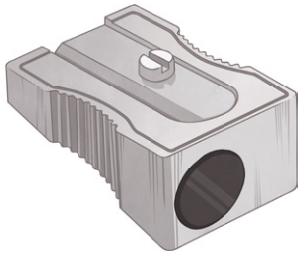

Ficha: Los Objetos De Mi Estuche

Ejercicio 1: Escribe el nombre de estos objetos del colegio.

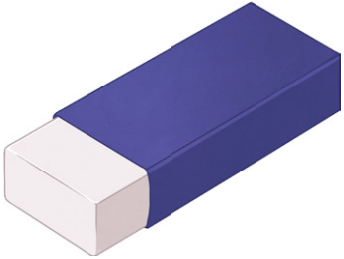
Exercise 1: Write the name of these school objects.

			
un b _____	un l _____	un r _____	un s _____

			
una r _____	una g _____	un l _____	unas t _____

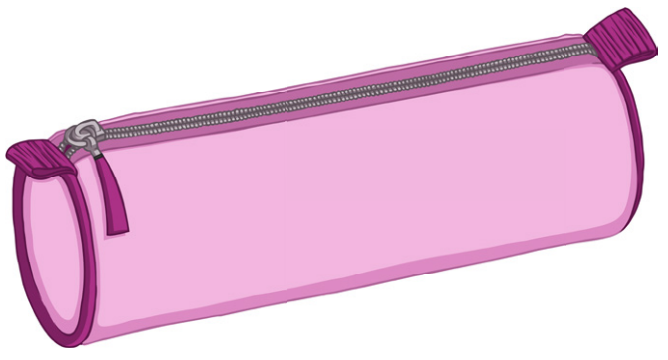
	
una b _____	un e _____

Ejercicio 2: Lee las frases y colorea los objetos del estuche.
Exercise 2: Read the sentences and colour the pencil case items.

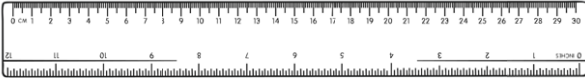

Mi regla es de color azul.

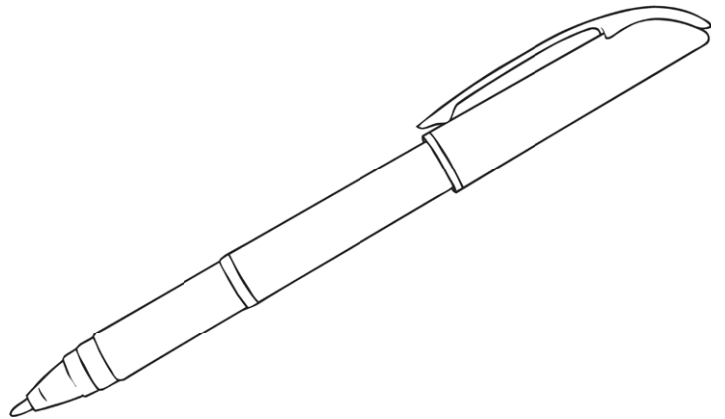

Mi bolígrafo es de color verde.

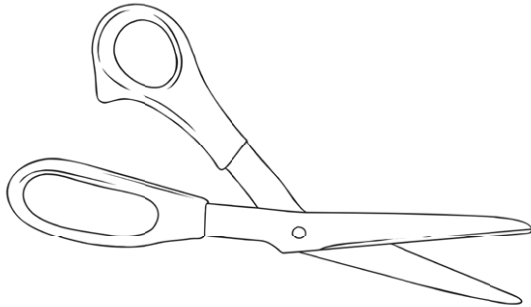

Mis tijeras son de color amarillo.

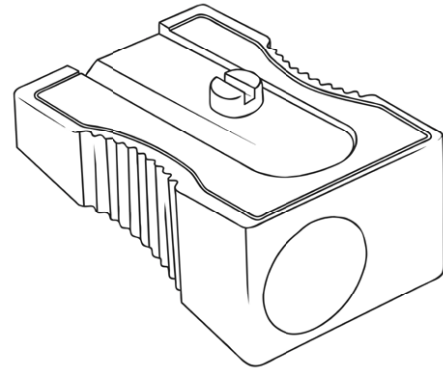

Mi sacapuntas es de color rojo.

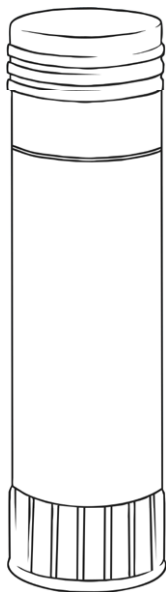

Mi pegamento es de color naranja.

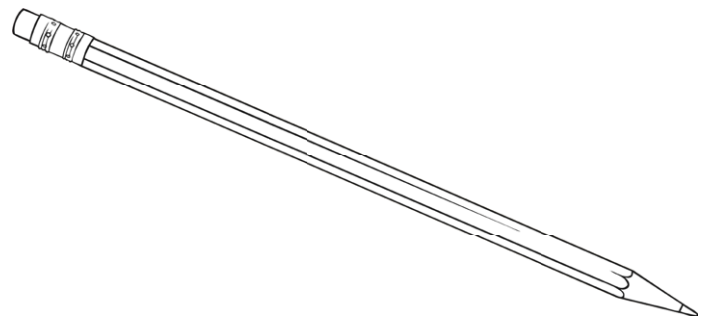

Mi lápiz es de color marrón.